

SIMRAD

TP10, TP22, TP32

User Guide

ENGLISH



Preface

As Navico is continuously improving this product, we retain the right to make changes to the product at any time which may not be reflected in this version of the manual. Please contact your nearest distributor if you require any further assistance.

It is the owner's sole responsibility to install and use the equipment in a manner that will not cause accidents, personal injury or property damage. The user of this product is solely responsible for observing safe boating practices.

NAVICO HOLDING AS AND ITS SUBSIDIARIES, BRANCHES AND AFFILIATES DISCLAIM ALL LIABILITY FOR ANY USE OF THIS PRODUCT IN A WAY THAT MAY CAUSE ACCIDENTS, DAMAGE OR THAT MAY VIOLATE THE LAW.

Governing Language: This statement, any instruction manuals, user guides and other information relating to the product (Documentation) may be translated to, or has been translated from, another language (Translation). In the event of any conflict between any Translation of the Documentation, the English language version of the Documentation will be the official version of the Documentation.

This manual represents the product as at the time of printing. Navico Holding AS and its subsidiaries, branches and affiliates reserve the right to make changes to specifications without notice.

Copyright

Copyright © 2014 Navico Holding AS.

Warranty

The warranty card is supplied as a separate document.

In case of any queries, refer to the our website:
www.simrad-yachting.com

Contents

3 General

- 3 Introduction
- 4 The SimNet network system

5 Operation

- 5 General
- 5 Standby mode
- 5 Autopilot mode
- 6 Adjusting course
- 6 Auto Tacking and Gybing

8 Advanced Features

- 8 Nav mode
- 8 Steer To Wind
- 9 Using an external compass

10 Configuration

- 10 Porthand mounting
- 10 Calibration mode
- 13 Autotrim

14 Installation

- 14 Fitting the Tillerpilot
- 16 Electrical installation
- 18 Interfacing via SimNet
- 19 Configuring the TP on the SimNet bus
- 20 Interfacing via NMEA
- 22 Electronic interference suppression
- 22 Auto compass calibration

23 Appendix

- 23 Advice on operation
- 24 Troubleshooting
- 26 NMEA sentences received
- 27 Spares & accessories
- 27 Mounting accessories
- 28 Dimensions
- 28 Specification

1



General

Introduction

The TP10, TP22, and TP32 Tillerpilots from Simrad are suitable for a wide variety of tiller-steered sailing yachts up to 12 m (39 ft) overall length.

Combining highly sophisticated electronics with advanced software and a powerful mechanical drive, they are capable of providing reliable and accurate steering performance under a variety of different conditions with minimal current consumption.

The Tillerpilots have been designed so that, while they represent the state-of-the-art in marine autopilots with many advanced features, they remain very simple to operate, using only five keys to access all functions.

Sophisticated functions of the TP22 and TP32 include Steer To Wind mode and Nav mode (Steer To GPS) using external equipment linked directly to the Tillerpilots via the SimNet high-speed bus, or through the built-in NMEA 0183 interface. There is also the option to operate the Tillerpilots remotely using a remote controller. For more details please refer to our website: www.simrad-yachting.com.

To ensure the best results from your Tillerpilot, it is essential that the unit is installed correctly. Please read this manual thoroughly before installation.

The SimNet network system

The SimNet system is built around a high-speed bus networking system, that allows the TP22 and TP32 to be easily interconnected to Simrad instruments and navigation equipment.

Units are interconnected and powered using a standard single cable.

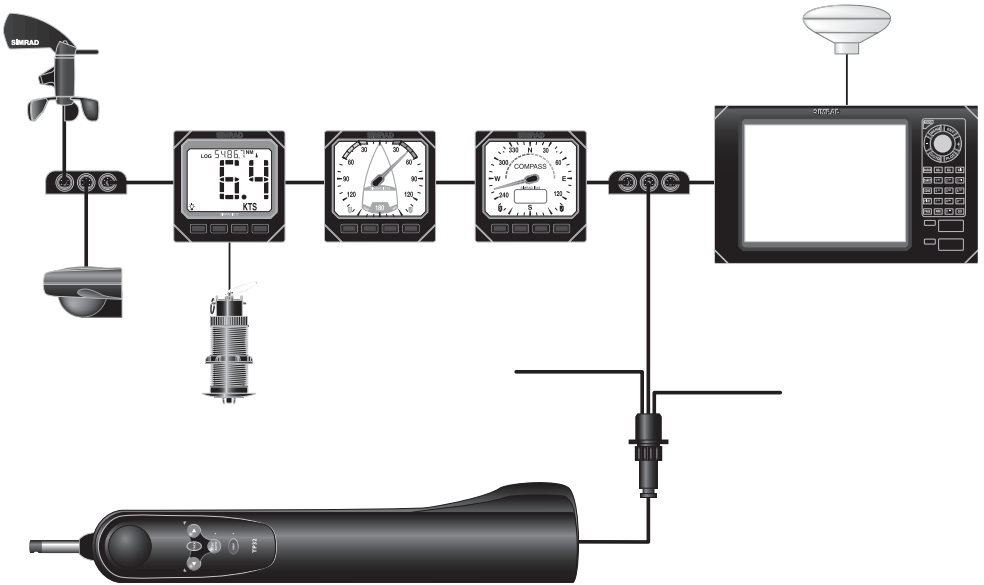

Typical SimNet system

The Tillerpilot can receive navigational information from the chartplotter for Steer To GPS (Nav mode).

It will also accept wind angle data from the wind transducer for Steer To Wind mode, boat speed data from the Speed instrument, and heading data from the compass transducer.

Additionally, heading data from the Tillerpilot's built-in fluxgate compass can be displayed on any instrument displays capable of showing compass information.

- ➔ **Note:** Heading data from the Tillerpilot will only be shown on instrument displays if there is no external compass transducer present on the network. Priority is always given to external compass transducers for heading data.

2

Operation

General

The Tillerpilots have no power key, and will be ON as long as power is connected.

The unit powers up in Standby mode indicated by a flashing LED next to the **STBY/AUTO** key. The two direction LEDs above the port (◀) and starboard (▶) keys are always dimly lit, which provides night illumination for the keypad. All functions are confirmed audibly by a “beep” and visually by the LEDs, so the status of the unit can always be confirmed at a glance.

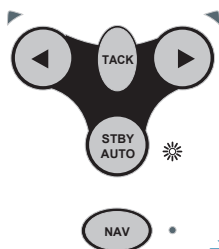

→ **Note:** The **NAV** key on the TP22 and TP32 is labeled **CAL** on the TP10. Both keys are referenced where applicable.

Standby mode

While in Standby mode, the pushrod can be manually driven in and out by pressing the arrowed port (◀) and starboard (▶) keys, which allows “power steering” of the vessel.

Autopilot mode

→ **Note:** The rudder zero position is captured at first time initiation of Autopilot mode. This information is however lost if the unit is turned OFF. Before initiating the Autopilot mode after a power down, you should ensure that the rudder is centered!

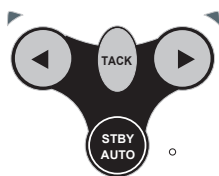

To engage Autopilot mode, press the **STBY/AUTO** key and the Tillerpilot will lock onto the current course. The LED next to this key will stop flashing and remain permanently lit as long as the pilot is in Autopilot mode.

To lock the pilot onto the desired course, either steer the correct course and then engage the autopilot, or engage the autopilot and then adjust the heading until the correct course is being sailed (see “Adjusting course” on page 6).

If the **STBY/AUTO** key is pressed and held, the pilot will beep a second time and lock onto the previously used heading (this feature will not be available if the unit has just been switched on).

Adjusting course

In Autopilot mode, precise course adjustments can be easily made:

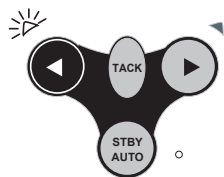

- Press the port (◀) or starboard (▶) key once and a 1° course adjustment will be made in the specified direction. This is confirmed by a single beep and the port or starboard LED will flash once.
- Press and hold either key and a 10° course adjustment will be made, confirmed by a double beep and a double flash of the port or starboard LED.

Auto Tacking and Gybing

The Tillerpilots has a built-in auto tack and auto gybe facility, allowing easy tacking and gybing of the vessel when single- or short-handed.

The Tillerpilots will automatically select tack or gybe depending on true wind direction:

- tacking if less than 90°
- gybing if larger than 120°

An auto tack/gybe is only possible in Autopilot mode.

To initiate autotack/gybe, press and hold the **TACK** key until both LEDs illuminate and you hear a short beep. To confirm the tack/gybe press the port (◀) or starboard (▶) keys key depending on which direction you wish to tack/gybe. The Tillerpilots will then beep 3 times with 1 second intervals, followed by a long beep when the tack/gybe starts.

The operation of the Tillerpilots will differ during an autotack/gybe, depending on whether the pilot is in Steer To Compass or Steer To Wind mode.

Autotacking/gybing in Compass mode

If in Compass mode (default), the Tillerpilots will tack/gybe the vessel in the selected direction through an angle of 100°.

Autotacking/gybing in Wind mode

The Tillerpilots will tack/gybe the vessel through to the same true wind angle, but on the opposite tack.

- ➔ **Note:** The Tillerpilots automatically prevents tacking/gybing in the wrong direction – if on port tack/gybe, only an autotack/gybe onto starboard will be possible.

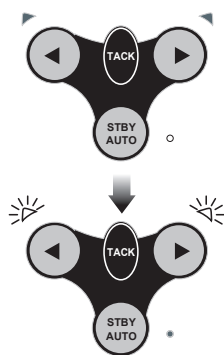

Autotacking/gybing in Nav mode

As the Tillerpilot will be steering directly to a waypoint, the autotack/gybe facility is disabled while in Nav mode.

If it is necessary to perform an autotack/gybe, disengage Nav mode by pressing the **NAV** key then perform the autotack/gybe.

 **Warning:** Ensure that the boat is on the correct tack before re-engaging Nav mode.

3

Advanced Features

The TP22 and TP32 Tillerpilots contain many advanced features, including the ability to accept course data from a variety of sources other than the internal fluxgate compass. Such sources include SimNet- and NMEA-compatible navigational receivers (GPS/chartplotters, etc.), wind vanes, and compass heading transducers.

Nav mode

The TP22 and TP32 Tillerpilots can interface directly with compatible Simrad chartplotters via the SimNet high-speed data bus. They also have an inbuilt NMEA interface, which allows connection to NMEA 0183-compatible GPS and chartplotters.

Once interfaced with a GPS or chartplotter, the Tillerpilot can steer using data from this source in addition to the internal compass, allowing it to steer to a waypoint with great accuracy.

To activate Nav mode, the unit must be in Auto mode (press **STBY/AUTO**). Simply activate a waypoint or route programmed into the GPS/chartplotter and press the **NAV** key. The LED next to the **NAV** key will light and the Tillerpilot will steer to the first waypoint using Cross Track Error and Bearing To Waypoint information from the navigational receiver to maintain an accurate course.

On arrival at the target waypoint an intermittent alarm will sound. As a safety feature, to avoid an unexpected course change, the next waypoint will not be automatically loaded until the **NAV** key is pressed. When the vessel reaches the final waypoint, the Tillerpilot will continue its current course under Compass (Auto) mode.

- **Note**: Some of the standard key stroke functions may have a different effect in Nav mode than in Compass mode (see “Adjusting course” on page 6 and “Autotacking/gybing in Nav mode” on page 7).

Steer To Wind

The TP22 and TP32 Tillerpilots can sail to the apparent wind angle rather than a compass course using wind data via NMEA interfaces or SimNet. Due to the faster data rate, the use of a SimNet windvane is recommended – priority will be given to SimNet Wind data over NMEA Wind data received by the Tillerpilot.

- **Note**: If no wind information is present, the Tillerpilot will not enter Steer To Wind mode.

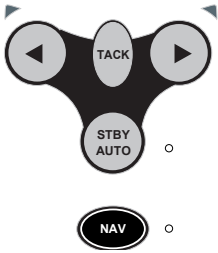

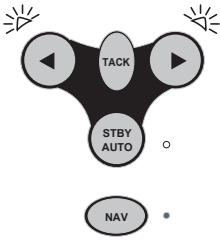

To select Steer To Wind mode, the unit must be in Auto mode (press **STBY/AUTO**). Press and hold the port (◀) and starboard (▶) keys together until a double beep is heard.

Both the port and starboard LEDs will flash simultaneously while the pilot is in Steer To Wind mode. To switch back to Compass mode, simply press and hold the ◀ and ▶ keys together again until a second beep is heard.

While in Steer To Wind mode, the Tillerpilot will lock onto the current apparent wind angle being sailed. Any course adjustments made will be relative to the apparent wind angle, rather than the compass heading as when in Compass mode.

Initiating an autotack will turn the boat onto the same apparent wind angle on the opposite tack. As a safety feature, autotack is disabled when sailing downwind.

→ **Note:** Nav mode cannot be selected while in Steer To Wind mode – to activate, return to Compass mode first.

Using an external compass

The TP22 and TP32 Tillerpilots will preferentially steer to external compass heading whenever such information is interfaced via the SimNet bus.

The use of an external compass is particularly important on a ferrous-hulled boat (i.e. steel, ferro cement, etc.), as the hull will affect the bearing read by the internal fluxgate compass.

On a steel- or ferro-hulled boat, the correct location for the external compass would be on the mast, between 1 and 2 meters above the deck. On a non-ferrous-hulled boat, the compass should be situated low down, as near the center point of the boat as possible, but away from any sources of magnetic interference such as speakers, etc.

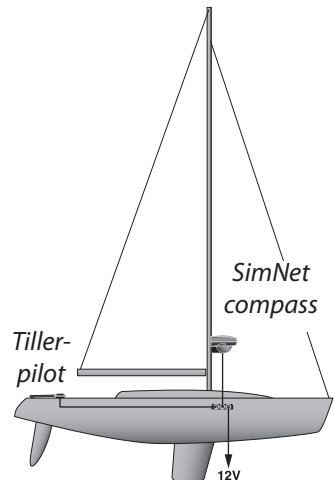

4

Configuration

Porthand mounting

Although the Tillerpilot is factory preset for starboard-side mounting, it is possible to reconfigure it for mounting on the port-side of the cockpit to facilitate easy installation on most types of yacht.

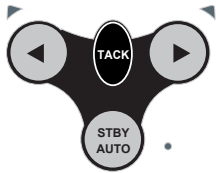

POWER ON

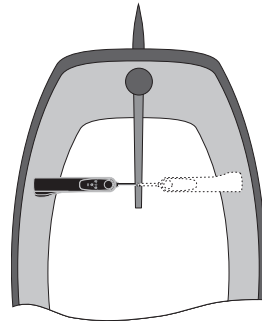
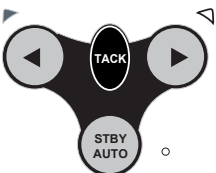
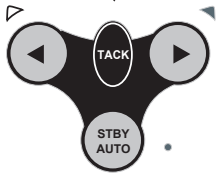
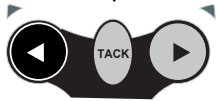

Starboard and Port mounting options

With the power off, hold down the **NAV (CAL)** and **TACK** keys and switch on the power. The port or starboard LED will illuminate, depending on the current mounting configuration. Press the port (◀) key to select port-side mounting – the port LED will illuminate to indicate selection. Confirm selection and exit to Standby mode by pressing **NAV (CAL)**.

To select starboard mounting, repeat the above procedure, but press the starboard (▶) key.

Calibration mode

The Response Control level and Seastate setting can be adjusted while the Tillerpilot is in either Standby or Autopilot mode:

- Press and hold the **TACK** key, then press **NAV (CAL)**
- The starboard LED will illuminate to indicate that Response Control adjustment is selected. To toggle between Response Control and Seastate adjustment, press **TACK** – the port LED will illuminate for Seastate.

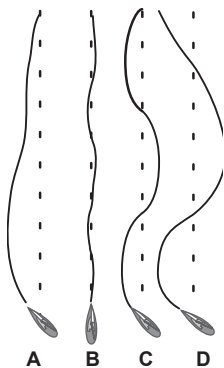

Adjusting Response Control (1-9)

The Tillerpilot will apply adjustments to the tiller, in order to compensate for heading variations, the amount of movement being proportional to the heading error detected by the compass unit. The amount of movement is set by the Response Control (sometimes referred to as the rudder ratio).

The Response Control setting can be likened to driving a motor vehicle – at high speeds, very little wheel movement is necessary to steer the vehicle (LOW Response). When driving at slow speeds, more wheel movement is necessary (HIGH Response).

The figure shows;

- **A:** Response Control too low – the vessel takes a long time to return to the correct heading.
- **B:** The ideal setting, where errors are quickly corrected
- **C:** Illustrates the effects of setting the Response Control too high, which causes the vessel to oscillate around the correct heading
- Excessive Response (**D**) creates a tendency to instability of course, leading to increasing error.

→ **Note:** When Seastate is set to “On”, the response control also include a deadband setting (see “Adjusting Seastate” below).

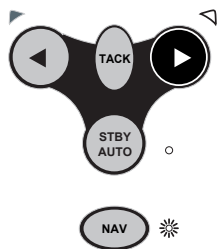

When Response Control is selected, the **NAV** LED will flash and a repeated sequence of beeps will be heard. The number of flashes and beeps in the sequence indicates the level of the Response Control setting.

- Use the port (◀) and starboard (▶) keys to adjust the Response Control setting between 1 and 9
- Press **NAV (CAL)** to confirm settings and return to normal operation, or press **TACK** to switch to Seastate adjustment.

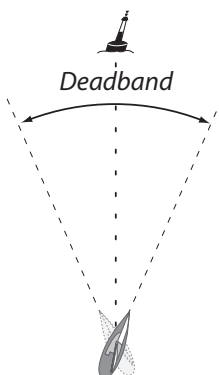

Adjusting Seastate (On/Off)

In heavy seas, more variations in heading will be detected. If the Tillerpilot tried to respond to all of these errors, it would be overworked, causing unnecessary strain to the unit and excessive drain on the batteries. By setting Seastate to “On”, a deadband within which the boat can go off course without constant corrections being made is added. The size of the deadband is now adjusted by the Response Control to give the best compromise between course holding and battery consumption. When Seastate is set to “Off”, a fixed minimum deadband applies to all response levels (1-9). See table on next page.

- In Calibration mode, press **TACK** to toggle between Response Control and Seastate adjustment (indicated by the port LED illuminated). The Seastate setting is indicated by the number of audible beeps and flashes of the Nav LED. Seastate (deadband) is "ON" if there is one beep/flash and "OFF" if there are two beeps/ flashes.
- Use the port (◀) and starboard (▶) keys to switch Seastate filter ON/OFF.
- Press **NAV (CAL)** to confirm settings and return to normal operation.

TP10/22/32 Tillerpilot Response Control

Response level	1	2	3	4	5	6	7	8	9
Rudder (Gain) Hi	0,3	0,3	0,4	0,5	0,5	0,6	0,6	0,7	0,7
Rudder (Gain) Lo	0,2	0,2	0,3	0,3	0,3	0,4	0,4	0,4	0,5
Counter rudder Hi	2,2	2,2	2,2	2,4	2,4	2,4	2,4	2,4	2,4
Counter rudder Lo	1,8	1,8	1,8	2,0	2,0	2,0	2,0	2,0	2,0
Seastate On, deadband	5,5	5,5	4,5	4,0	3,5	3,0	2,5	2,0	1,5
Seastate Off, deadband	0,5	0,5	0,5	0,5	0,5	0,5	0,5	0,5	0,5

Whether you are operating in Hi or Lo parameter range depends on boat speed and wind angle.

When beating and reaching Hi or Lo only depend on boat speed:

Below 4 knots > Hi

Above 4 knots > Lo

So if you lose too much speed e.g. when tacking, the parameters will change from Lo to Hi to gain sufficient rudder response.

When running (apparent wind angle -140 to +140 degrees) you will always be operating in Hi, independent of boat speed.

Hi/Lo depending on boat speed:

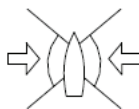

Always Hi:

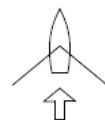

Autotrim

Under differing conditions a tiller bias (sometimes known as standing helm or rudder trim) is applied in order to steer a straight course. An example is when sailing close-hauled, where the vessel will normally pull into the wind, and the helmsman applies a standing helm to leeward, in order to maintain course. The amount of this standing helm varies according to factors such as strength of wind, boat speed, sail trim, and amount of sail set. If no account of these were taken, then the vessel would tend to veer off course, or pull around head-to-wind when sailing close-hauled.

The Tillerpilot continuously monitors the average course error and applies a bias to the tiller to compensate, until the optimum condition is reached. This bias, or standing helm, is applied gradually, so as not to upset the normal performance of the Tillerpilot. Thus, it may take up to a minute or so to fully compensate after changing tack. Once optimum trim is reached, the pilot will still monitor for changes in the prevailing conditions and update the trim accordingly.

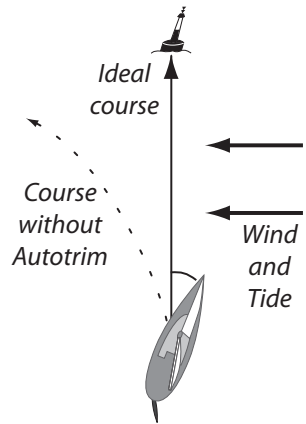

→ **Note:** Autotrim is applied automatically and cannot be manually adjusted.

5

Installation

Fitting the Tillerpilot

The Tillerpilot is a very sophisticated piece of equipment and, therefore, in order for it to function to its full capabilities, it is essential that it is installed correctly. Please read this section thoroughly before attempting installation and use.

The Tillerpilot should be horizontally level when fitted to the tiller.

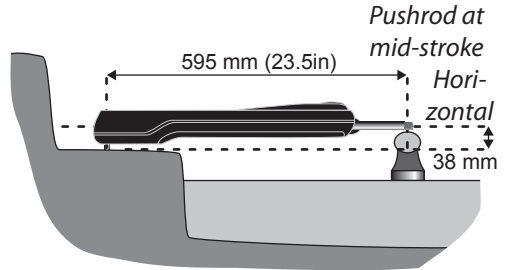

With the tiller amidships and the pushrod in the midstroke position, the Tillerpilot should be exactly 90° to the tiller.

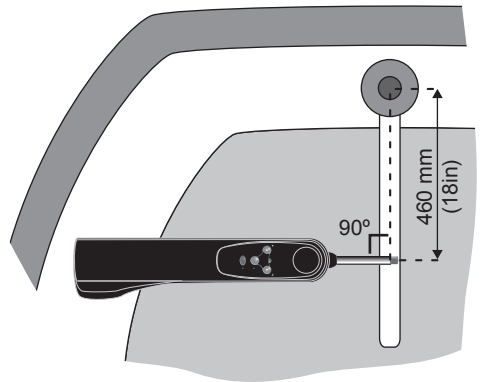

- **Note:** The pilot is factory preset to be mounted on the starboard side as shown, but this can be reconfigured for port-side mounting (see “Porthand mounting” on page 10).

The dimensions should be adhered to as closely as possible.

- **Note:** If the dimensions given are not practical for the vessel to which the Tillerpilot is to be fitted, a range of fitting accessories are available to facilitate correct installation. (Please refer to “Spares & accessories” on page 27 for more details.)

⚠ Warning: The Tillerpilot houses an internal fluxgate compass and should therefore be mounted away from sources of magnetic interference, such as the vessel's steering compass or external loudspeakers. The minimum safe distance is 1 m (3ft 3in).

The Tillerpilot is mounted using a supplied tillerpin and mounting cup, which allows the unit to be fitted and stowed easily.

To fit the tillerpin, drill a 6.3 mm (0.25 in) hole in the tiller (ensure that this is on the centerline of the tiller and is vertical). Drill to a depth that allows only the top 18 mm (0.75 in) to protrude. Fix in place using an epoxy adhesive.

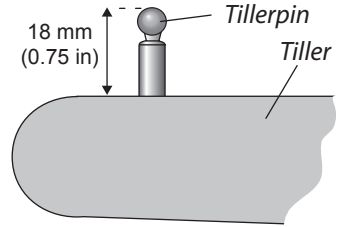

To fit the mounting cup, drill a 12.7 mm (0.5 in) hole into the cockpit seat and mount, so that only the flange protrudes. Ensure the cup is a tight fit (use an epoxy adhesive) and is supported over its entire depth – if necessary, reinforce the underside of the cockpit seat with hardwood or marine plywood.

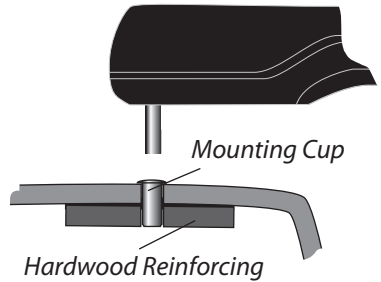

→ **Note:** Due to the high loads exerted, do not fit the Tillerpilot to the mounting cup and pin until the adhesive has completely set.

Electrical installation

Installing the TP22 and TP32

The Tillerpilot operates from a 12 V DC supply. The waterproof plug fitted to the Tillerpilot is used to supply the power, SimNet and NMEA data. The bulkhead socket should be mounted in a convenient position, close to where the Tillerpilot is to be fitted, and wired as shown.

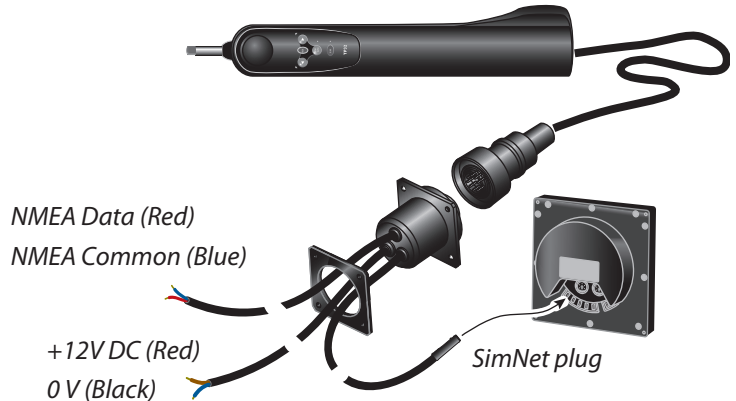

⚠ Warning: If the vessel has more than one separate battery bank, when connecting the Tillerpilot to the power supply, always ensure that the pilot and all interfaced equipment—whether SimNet or NMEA—are connected to the same battery bank, even if they each have independent connections to the switch panel. This is to avoid a possible voltage drop between the interfaced equipment, which would render the equipment inoperative.

Power cable selection table

Length of cable run	Cross section	Conductor type	AWG
Under 4 m (13 ft)	1.5 mm ²	30/0.25	16
4 - 8 m (27 ft)	2.5 mm ²	50/0.25	14

- Mount the bulkhead socket on a vertical surface to prevent standing water gathering around or in the socket. Always fit the protective cap when the pilot is not plugged in

- No power is supplied to or from the SimNet bus – the Tillerpilot must always have its own dedicated power connection
- Use a suitable gauge cable to run from switch panel to the socket
- Connect to the vessel's switch panel via a 10 Amp fuse or breaker
- Do not fit other electronic or electrical equipment to the supply cable or "tap into" the supply from a nearby cable – always wire each piece of equipment to its own breaker in the switch panel
- Ensure all wire ends are tinned, and any connections are well made. Poor contact will result in loss of thrust from the Tillerpilot and slower speed of response
- If in any doubt, employ a qualified engineer

Installing the TP10

The TP10 Tillerpilot operates from a 12 V DC supply and is connected to the supply by two wires. Although the cable is supplied with bare ends, it is recommended that a good quality waterproof plug and socket set is fitted for maximum reliability. A suitable plug and socket set is available as an optional accessory (part no. SKT100; see "Spares & accessories" on page 27).

Wire to the electrical supply as follows:

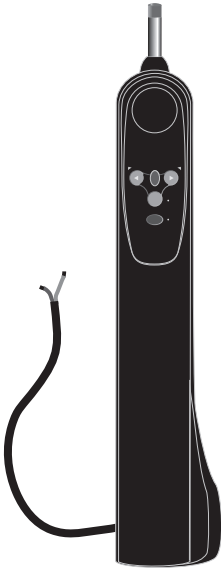

Wire color	
Brown	+ 12 V DC
Blue	0 V

- Use a suitable gauge cable for the run from the socket to the supply (see previous page)
- Connect to the vessel's switch panel via a 10 Amp fuse or breaker.
- Do not fit other electronic or electrical equipment to this cable, or "tap into" the supply from a nearby cable – always wire each piece of equipment to its own breaker in the electrical panel
- Ensure all connections are well made. Poor contact will result in loss of thrust from the Tillerpilot and slower speed of response
- If in any doubt, employ a qualified engineer to install the equipment

Interfacing via SimNet

The TP22 and TP32 Tillerpilots are linked to other SimNet-compatible equipment via the integral SimNet cable and plug in the bulkhead socket.

All SimNet units (Instruments, Chartplotters, Radars, Autopilots, etc.) use the same single cable to share data on the high speed network. If there are no spare SimNet ports convenient, a three-way cable joiner can be used to create an additional port.

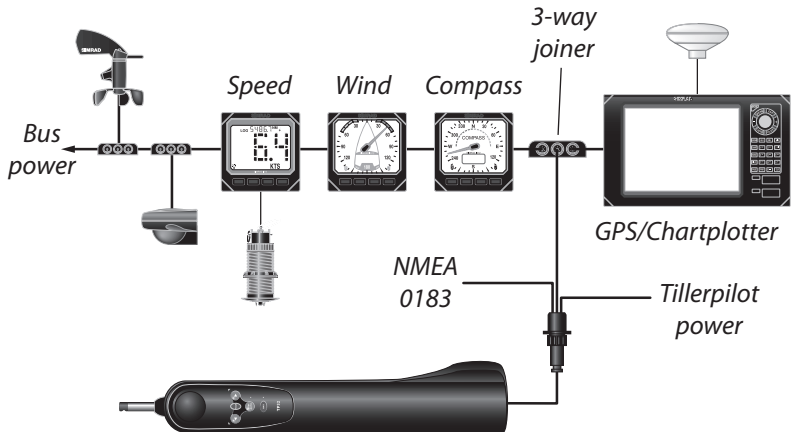

- **Note:** It is not necessary to plug the Tillerpilot directly into any equipment that you wish to share data with – all data is transmitted across the whole bus network.

Configuring the TP on the SimNet bus

Normally the TP22 and TP32 can be connected to the SimNet bus and will automatically share data sources with other SimNet units without any required user intervention.

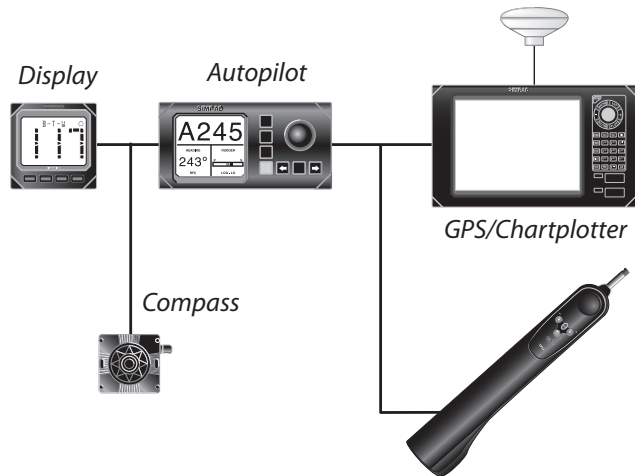

Two operation modes are available:

System mode
(default)

The Tillerpilot automatically shares data sources with other SimNet units. Source selection can be done from any SimNet unit using shared data resources

StandAlone mode

The Tillerpilot will not automatically share data sources with other SimNet units, other than AP24 or AP28 control units included in the system. These will always share data sources with the Tillerpilot. The data sources for the Tillerpilot and the AP24/AP28 can be selected from the AP24/AP28 control unit.

To change the mode, first turn off the Tillerpilot

- To select System mode (default), press and hold the **TACK**, **STBY/AUTO** and **NAV** keys while turning power on

- To select StandAlone mode, press and hold the **TACK** and the port (◀) keys or **TACK** and starboard (▶) keys while turning power on

Keep the keys pressed until the Tillerpilot beeps 3 times and all the LEDs light briefly to confirm the new configuration.

- **Note:** Please refer to the instructions supplied with the relevant command unit for details on remote configuring of data sources.
- **Note:** If there is more than one data source on the SimNet bus, but no command unit capable of re-configuring the Tillerpilot present, the required data source must be the only one present on the bus when StandAlone mode is selected. Power down or disconnect any multiple sources until after the operation mode selection process is complete.
- **Note:** Changing the operation mode, or even re-selecting the same mode, will reset any data source selections that the Tillerpilot was previously locked on to.
- **Note:** If any one of the external data sources is replaced, then the Tillerpilot must be instructed to use the new data source by following the relevant procedure for StandAlone or System mode.

Interfacing via NMEA

The inbuilt NMEA processor allows NMEA 0183-compatible equipment to be connected directly to the TP22 and TP32, without any need for a separate interface unit.

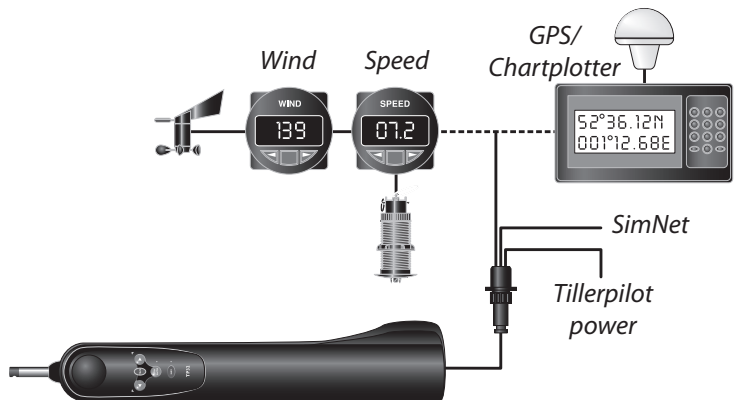

If a GPS or chartplotter is connected to the Tillerpilot, it can extract the data necessary for Nav mode. Other functions, such as Steer To Wind, may also be available if NMEA 0183-compatible instruments are transmitting the correct NMEA sentences.

When connecting an external (“talker”) unit to the Tillerpilot, two terminals are used – usually labeled DATA and COMMON (or COM). These should be connected to the Tillerpilot’s NMEA cable as follows:

NMEA talker unit	Tillerpilot NMEA
NMEA Out Data/+	Data (Red)
NMEA Out Common/-	Common (Blue)

→ **Note:** Some third party equipment does not have a dedicated COMMON connection. In this case, the DATA connection will usually be labeled NMEA OUT and the NMEA Common wire from the Tillerpilot should be connected directly to 0 V (terminal 2). If in any doubt, refer to the manufacturer or Simrad’s Product Support department for advice.

⚠ Warning: Due to the limitations of NMEA 0183, it is recommended that only one talker is transmitting to the Tillerpilot at any one time – i.e. instruments or GPS/chartplotter, not both simultaneously! If more than one unit needs to be interfaced to the Tillerpilot, these should be connected to the NMEA cable via a changeover switch.

Because of the vast number of different manufacturers and models of navigational equipment, Simrad cannot guarantee correct operation and installation of third party equipment. Therefore, before connecting any equipment to the Tillerpilot it is important that the unit’s manual is referred to with regard to interfacing via NMEA.

Electronic interference suppression

The Tillerpilot has been designed to minimize the effects of interference generated by the engine alternator. However, precautions should still be taken by routing the cables away from the engine compartment. Do not run the cables down trunking carrying high current or radio antenna cables.

Engines with spark ignition, also some refrigerators, should be fitted with suppressors. Your local agent should be able to advise on this and supply suppression kits where necessary.

Auto compass calibration

Once the Tillerpilot is installed, it is necessary to calibrate the internal compass to compensate for deviation caused by any metallic or magnetic objects surrounding it on the vessel.

With the vessel motoring slowly (2–3 knots) in calm conditions and the Tillerpilot in Standby mode, press the starboard (▶) key a number of times to induce a slow, clockwise rotation of the vessel. Then press and hold the TACK key, followed by the port (◀) and starboard (▶) keys simultaneously.

The port and starboard LEDs will both light. Allow the vessel to turn through a minimum of 1 1/4 turns (450°) in approximately two minutes, during which time the fluxgate compass will automatically calibrate itself.

If the rate of turn or boat speed is too fast, the port LED will flash. Either slow the boat, or reduce the angle of turn. If the rate of turn or boat speed is too slow, the starboard LED will flash – either increase the boat speed, or increase the angle of turn. A short beep will indicate that the calibration has been successful and the Tillerpilot will return to Standby mode. If the calibration has been unsuccessful, after a period of four minutes a long beep will sound.

- **Note:** If the calibration routine keeps failing after repeated attempts, the Tillerpilot may be experiencing excessive magnetic deviation that it cannot compensate for. Check the area within 1 m (3 ft) of the Tillerpilot for likely sources, such as cockpit speakers or large metallic objects – if these cannot be relocated, it may be necessary to fit an external compass (“Using an external compass” on page 9).

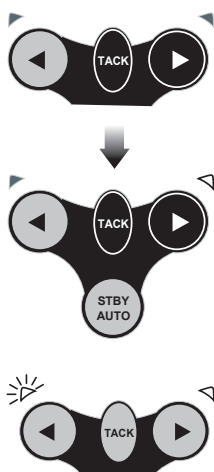

6

Appendix

Advice on operation

When used correctly, your Tillerpilot can maintain as good a course on most points of sail as a skilled helmsman, with the advantage that it never gets distracted. A human can start showing lapses of concentration after as little as 10 mins.

The following advice should improve efficiency when sailing using your Tillerpilot:

- 1.** When sailing close to the wind, it is easy to forget to trim the mainsail, allowing excessive weather helm to build up. Where a human helmsman can quickly weigh up the situation and adapt to circumstances, the autopilot will struggle on and the boat will be sailed less efficiently. Whereas a human normally likes to feel some weather helm, this is not necessary for the functioning of the Tillerpilot. Power consumption, wear, and drag will be greatly reduced, if the mainsail is freed or reefed a little sooner than normal when sailing manually.
- 2.** It is also advisable, when sailing close-hauled, to set a course a few degrees free of that normally sailed under manual control, to avoid luffing into the wind.
- 3.** When running dead downwind, a human pilot can see visual signs warning him if the boat is about to gybe, which the Tillerpilot cannot sense – it is advisable not to sail as close to the gybe as you may do when sailing manually.
- 4.** When broad reaching or running fast, particularly with quartering waves, a helmsman will naturally apply periodic larger angles of helm than when beating or sailing slowly. This is the equivalent of increasing rudder gain, and it may be a good idea to adjust the Response control on the Tillerpilot. Many people prefer to find a compromise setting which is used for all sailing, but with practise it can be optimized for different conditions, e.g. low for motoring in a calm sea, or high for running fast. If the Response control is set too low, the boat will go off course, because insufficient rudder is applied in time; if the Response control is too high, the boat will overcorrect, increasing power consumption.
- 5.** The Tillerpilot is a highly advanced piece of equipment. However, it would be a mistake to become complacent. As with all electronic navigational equipment, it is an aid to navigation and should not be used as a substitute for conventional navigational practise.

Troubleshooting

Symptom	Probable Cause	Remedy
When engaged, the pilot immediately applies a large helm angle and increases course error	<ul style="list-style-type: none"> - Tillerpilot is configured for port hand setting but installed on starboard side (or vice versa). 	<ul style="list-style-type: none"> - Refer to "Porthand mounting" on page 10
After functioning normally course is suddenly lost and the Tillerpilot goes into Standby mode	<ul style="list-style-type: none"> - Power interrupted briefly, or low voltage - Cable used to socket too small - Intermittent connection 	<ul style="list-style-type: none"> - Increase size of cable - Check all connections - Charge batteries - Uprate batteries
Helm is hard over and alarm is continuously on	<ul style="list-style-type: none"> - Steerage way insufficient to control course, or sails are aback. Pulsing is a correct safety feature when tiller is at full travel. 	<ul style="list-style-type: none"> - Reset the vessel on course and re-engage pilot
Power socket is live, but pilot is not on.	<ul style="list-style-type: none"> - Socket is wired incorrectly 	<ul style="list-style-type: none"> - Check wiring of socket. ("Electrical installation" on page 16)
Loss of course under Steer To Wind mode.	<ul style="list-style-type: none"> - Apparent wind has become too light to give a consistent direction 	<ul style="list-style-type: none"> - Change to Compass mode
Cannot select Steer To Wind mode	<ul style="list-style-type: none"> - Masthead unit is not connected. - SimNet system is not switched on or powered. - Required NMEA sentence not being transmitted 	<ul style="list-style-type: none"> - Check connections - Check system is on - See "NMEA sentences received" on page 26 & check NMEA connections.

Symptom	Probable Cause	Remedy
Cannot select Nav mode	<ul style="list-style-type: none"> - GPS/Chart Plotter not connected - Waypoint not active - Wrong NMEA format is being used 	<ul style="list-style-type: none"> - Check connections - Activate waypoint/route - Check NMEA 0183 format is being transmitted by navigational receiver.
Autotack function not working	<ul style="list-style-type: none"> - Pilot is in Nav Mode - Pilot is in Steer To Wind Mode and <ul style="list-style-type: none"> a) apparent wind is >90° b) autotack being attempted is in the wrong direction 	<ul style="list-style-type: none"> - Exit Nav Mode - Luff up until apparent wind is less than 90°.
Pilot does not hold accurate course in Auto mode	<ul style="list-style-type: none"> - Fluxgate compass is being affected by interference from nearby magnetic influences (binnacle compass, speakers) or metallic objects (winches, deck hardware etc). 	<ul style="list-style-type: none"> - Check compass has been calibrated ("Auto compass calibration" on page 22). - Fit external SimNet compass. - Replace binnacle compass - Relocate objects that are causing interference.

These simple checks should be carried out before seeking technical assistance and may save time and expense. Before contacting your servicing agent, please note the Tillerpilot's serial number.

NMEA sentences received

The NMEA 0183 information required for full functionality of the TP22 and TP32 whilst in Nav mode is as follows:

- Cross Track Error
- Bearing to destination waypoint
- Arrival at waypoint indication
- Magnetic variation
- Boat speed

This information is extracted from the following NMEA 0183 sentences:

Received	Data
APA	Cross Track Error, bearing to/arrival at waypoint
APB	Cross Track Error, bearing to/arrival at waypoint
RMA	Speed & course over ground & magnetic variation
RMB	Cross track error, bearing to/arrival at waypoint (T)
RMC	Speed & course over ground & magnetic variation
BWR	Bearing to/arrival at waypoint (rhumb line)
BWC	Bearing to/arrival at waypoint (great circle)
BWW	Bearing waypoint to waypoint
VHW	Boat Speed
XTE	Cross Track Error

The Tillerpilot also extracts the apparent wind angle from the following NMEA 0183 sentences:

Received	Data
VWR	Apparent Wind Speed & Angle
MWV	Apparent Wind Speed & Angle

Spares & accessories

The following spares and accessories are available from local Simrad agents. Please quote the part number when ordering.

TPPK7	Tillerpin, Mounting Cup & Pushrod End Cap
SKT100	Waterproof Socket & Cable Assembly (TP10)
SKT22/32	Waterproof Bulkhead Socket & Cable Assembly (TP22 and TP32)

→ **Note:** Refer to www.simrad-yachting.com for range of compatible displays and controllers.

Mounting accessories

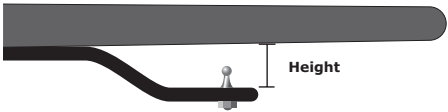
Tiller Brackets		Part No	Height
		TB30	30mm (1.18")
		TB60	60mm (2.36")
		TB90	90mm (3.54")
		TB120	120mm (4.72")

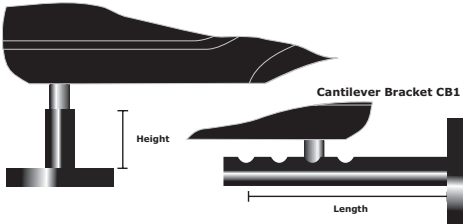
Pedestal & Cantilever Brackets		Part No	Height / Length
		PB30	30mm (1.18")
		PB60	60mm (2.36")
		PB90	90mm (3.54")
		CB1	135 - 240mm (5.31 - 9.44")

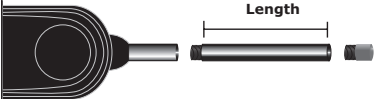
Push Rod Extensions		Part No	Length
		PRE30	30mm (1.18")
		PRE60	60mm (2.36")
		PRE90	90mm (3.54")
		PRE120	120mm (4.72")
		PRE150	150mm (5.90")
		PRE300	300mm (11.81")

Dimensions

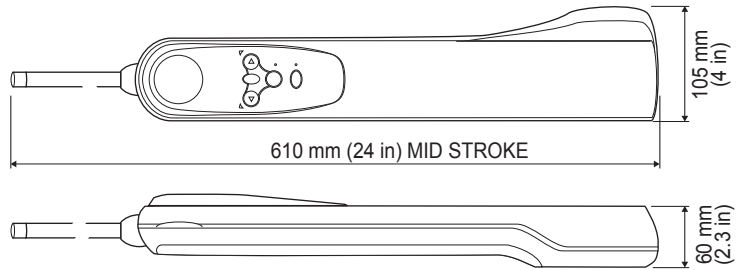

Specification

Supply Voltage	12 V (10–16 V) DC
Current Consumption (Typical)	Standby – 60 mA Auto – 500 mA
NMEA Format (TP22 & TP32)	Compliant with NMEA0183 versions 2.0, 2.3 and 3.0 (4800 baud, no parity, 8 bits, 1 stop bit)
Drive System	TP10 – Screw thread
	TP22 – Screw thread
	TP32 – Recirculating ballscrew
Operating Stroke	250 mm (10 in)
Peak Thrust	TP10 – 65 kg (143 lbs)
	TP22 – 70 kg (154 lbs)
	TP32 – 85 kg (187 lbs)
Hardover time	0 kg P10 – 6.9 secs TP22 – 6.9 secs TP32 – 4.0 secs
	20 kg TP10 – 8.0 secs TP22 – 8.0 secs TP32 – 4.7 secs
	40 kg TP22 – 12.0 secs TP32 – 6.0 secs
	50 kg TP32 – 8.0 secs
Ambient Temp Range	-10°C to +55°C (14°F to 131°F)
Mounting	Starboard as default (can be reversed)



SIMRAD